

## Three Wires Single Circuit - Spotlight

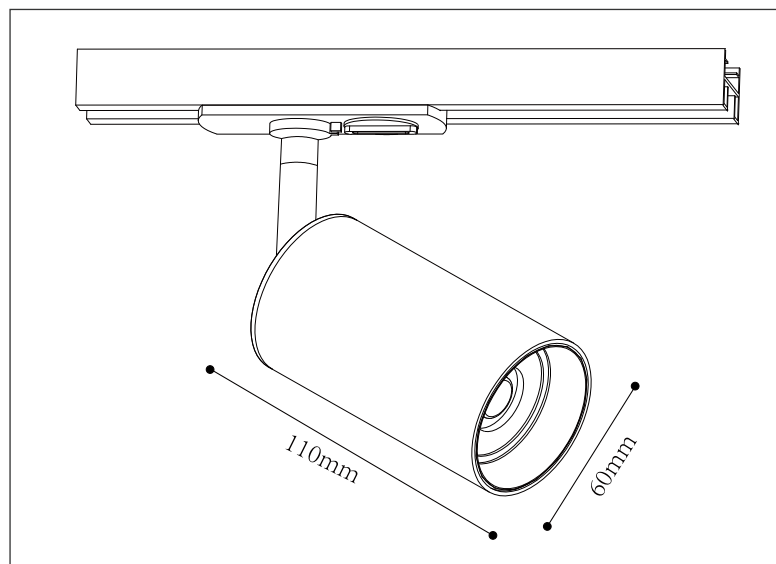

### Technical Specification

Art No.: LIC-T005

Light Source: GU10 (not included)

Material: Aluminum

Power Supply: AC220-240V 50/60Hz

Finish Color: Black/White

Power: Max 7W

