

## Mini Two Wires Single Circuit - Spotlight

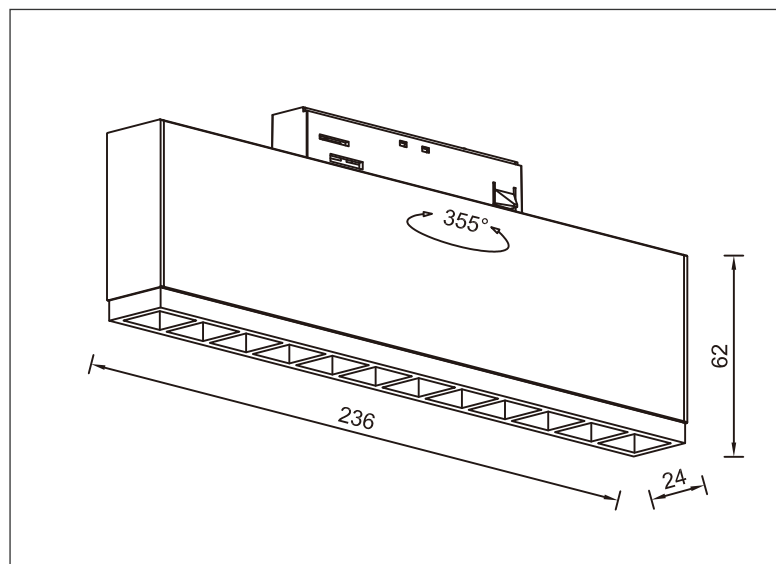

### Technical Specification

Art No.: LIC-MTLED055-10

Material: Aluminum+PC

Finish Color: Black/White

Driver Type: Integrated Driver

Power Supply: AC220-240V 50/60Hz

System Power: 10W

Power Factor: >0.5

Light Source: LED/SMD

Luminous Flux: 800 lm

CCT: 2700K/3000K/4000K

Color Rendering Index: CRI: ≥90

Optic: Lens

Beam Angle: 24° /36°

Lifespan: 30000Hrs

