

Mini Two Wires Single Circuit - Spotlight

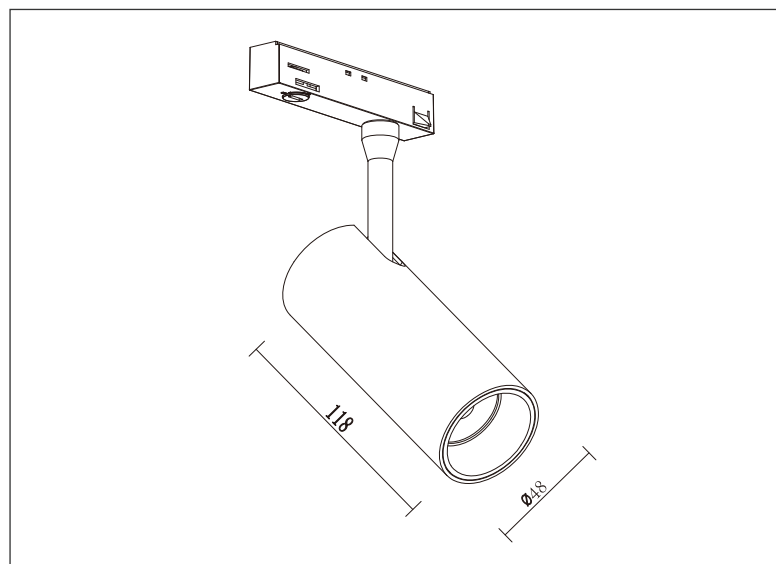

Technical Specification

Art No.:	LIC-MTLED031-10	Light Source:	LED/COB
Material:	Aluminum+PC	Luminous Flux:	500 lm
Finish Color:	Black/White	CCT:	2700K/3000K/4000K
Driver Type:	DOB	Color Rendering Index:	CRI: ≥90
Power Supply:	AC220-240V 50/60Hz	Optic:	Lens
System Power:	10W	Beam Angle:	24° /36°
Power Factor:	>0.5	Lifespan:	30000Hrs

