

Mini Two Wires Single Circuit - Spotlight

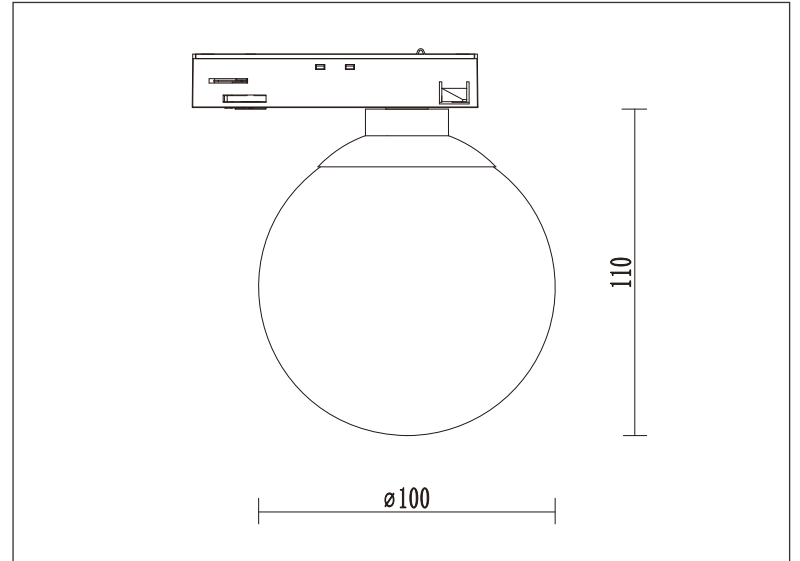

Technical Specification

Art No.:	LIC-MT1102	Light Source:	G9 (not included)
Material:	Aluminum	Power Supply:	AC220-240V 50/60Hz
Finish Color:	Black/White	Power:	Max 3W

